

RELO V

VENTILATION DRAINAGE GRATE

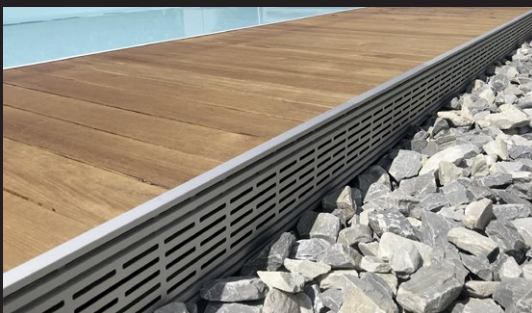
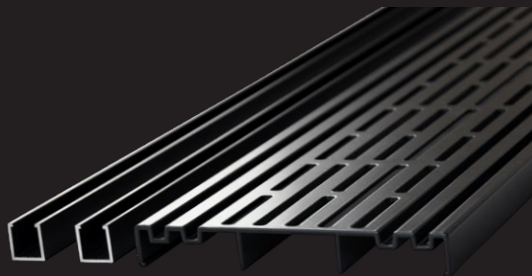
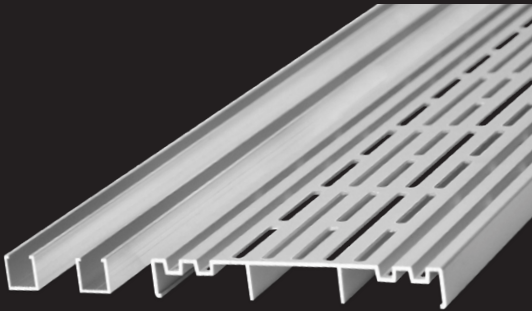

The ventilation drainage grate **RELO V** is perfectly suited to any decking project. The aluminum profile with the high-quality anodized finish seamlessly integrates into any terrace, creating a harmonious transition to adjacent objects.

Drainage occurs through the profile recesses, directing water directly into the substrate, significantly reducing staining caused by spray water on adjacent objects such as house walls, doors and windows. RELO V, with its 150 mm width, complies with flat roof design guidelines.

In addition, RELO V ensures optimal ventilation for the entire terrace structure while preventing early damage due to waterlogging and moisture buildup beneath the terrace.

The RELO V profile can be installed as a side panel, offering exceptional side ventilation to the terrace construction. These panels can be affixed using either the RELO VH holder or the RELO RA edge finishing trim. RELO VB trim permits an aesthetically pleasing edge finish.

The ventilation and drainage grate are inserted into the pre-assembled RELO VA support profiles and individually screwed in place at specific points. If necessary, it can be easily disassembled for maintenance work.

OVERVIEW	RELO V	RELO VA support profiles	RELO RA
Dimensions:	1.200x150x20 mm	1.880x18x17 mm	Length 2.000 mm
Material:	Aluminium EN AW 6060	Aluminium EN AW 6060	Aluminium EN AW 6060
Surface:	Silver Anodized E6/EV1 RAL 7016	Aluminium blank RAL 7016	Silver Anodized E6/EV1
Accessories:	RELO VA support profiles RELO VB end-cover E6/EV1 RELO VH holder aluminium blank	System screws UNIA 4,2x22-28 mm EPDM pads GUMO L 2-8 mm, depending on height adjustment	RELO VA support/mounting profile for side mounting of RELO V

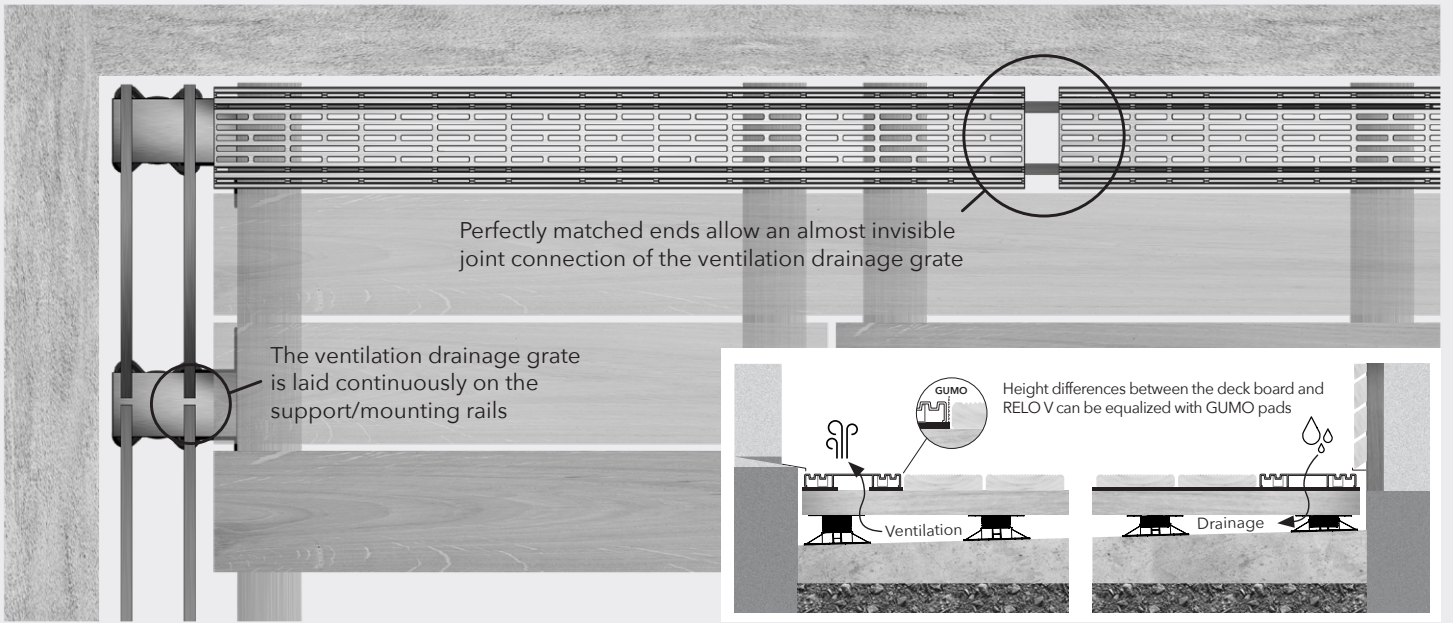

ACCESSORIES FOR SIDE PANELING:

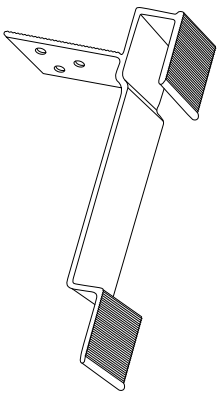

RELO VH holder

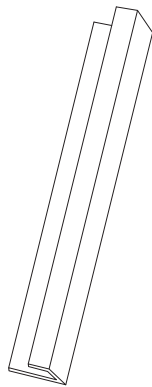

RELO VB end-cover

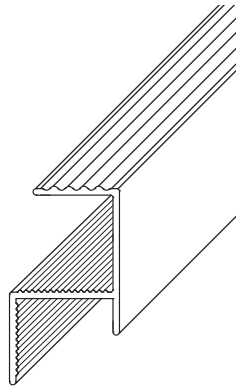

RELO RA edge finishing trim

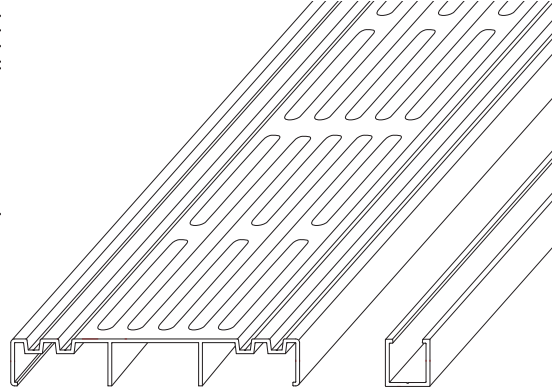

RELO V ventilation drainage grate

RELO VA support profile

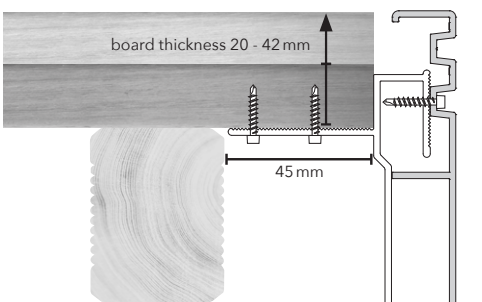

RELO VH is pre-mounted to the deck board
RELO V and RELO VH can be cut to length

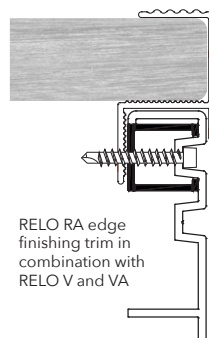

RELO RA edge finishing trim in combination with RELO V and VA

DOWNLOADS

QR code for Downloads

Installation (V|VA)

QR code for Installation (V|VA)

Installation (VH|VB)

QR code for Installation (VH|VB)

Data sheet

QR code for Data sheet

Tips & Tricks

QR code for Tips & Tricks

RELO V-SET E6/EV1	
PU	Prod. No.
10 PCS	* 014420000
incl. UNIA 4.2x22 mm	

RELO V-SET RAL 7016	
PU	Prod. No.
10 PCS	* 034120000
incl. UNIA 4.2x22 mm	

RELO VH-SET blank	
PU	Prod. No.
12 PCS	033305000
incl. UNIA 4.2x17 mm	

RELO VB-SET E6/EV1	
PU	Prod. No.
12 PCS	033203000
incl. UNIA 4.2x22 mm	



SET-PACK
Each package contains all the UNIA system screws required for mounting and assembly instructions.

RELO VA blank	
PU	Prod. No.
14 PCS	* 014520000

RELO VA RAL 7016	
PU	Prod. No.
14 PCS	* 034220000

RELO RA 19-22 E6/EV1	
PU	Prod. No.
10 PCS	* 033400000

RELO RA 23-26 E6/EV1	
PU	Prod. No.
10 PCS	* 033500000



BRANDING
Custom branding upon request

* no branding possible